

PART NAME NEMA 4X DIE CAST ALUMINUM ENCLOSURE

PART No. AN-1304, AN-1304-G, AN-2804 & AN-2804-B

REV. DATE 12-17-08

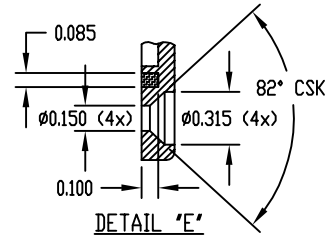
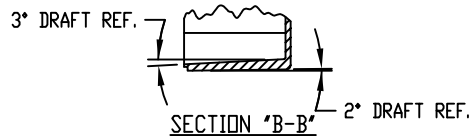
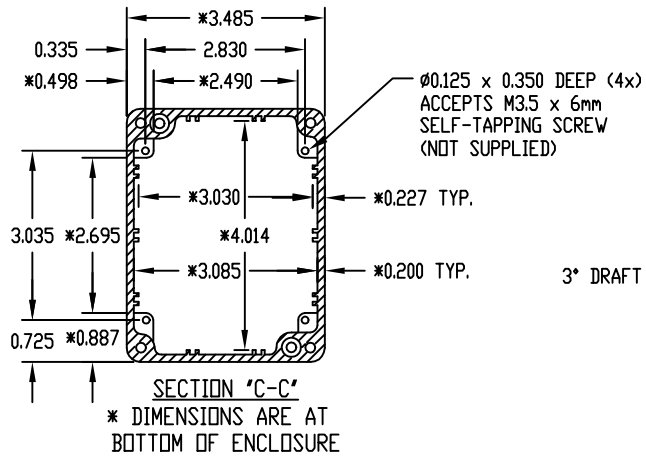

MATERIAL: ALUMINUM ALLOY #ADC-12

FINISH: NATURAL (NO SUFFIX)
 GRAY (SUFFIX -G)
 SMOOTH BLACK (SUFFIX -B)

- NOTES:
- FOUR (4) M4 x 20mm (0.787") LG. SCREWS SUPPLIED FOR ASSEMBLY OF COVER TO BODY.
 - ALL HOLE DIAMETERS HAVE ±0.005 TOLERANCE ALL OTHER DIMENSIONS HAVE ±0.015 TOLERANCE

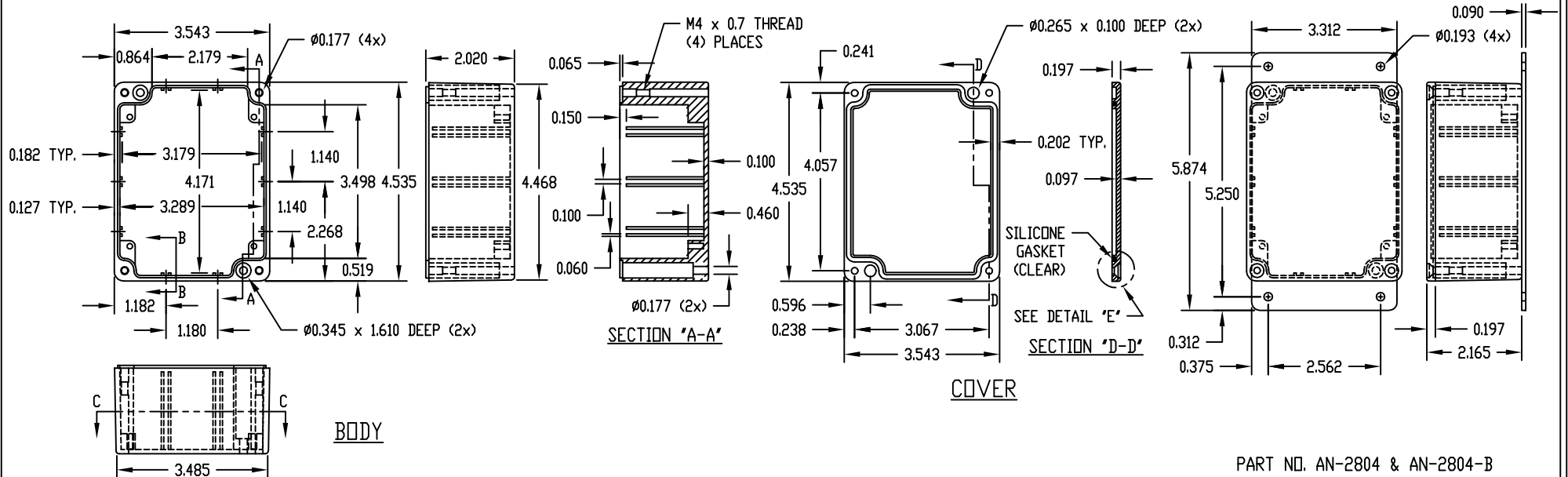

PART NO. AN-2804 & AN-2804-B ARE SUPPLIED WITH A WELDED ON MOUNTING BRACKET ONLY.